

## REPLACEMENT PARTS DRINKING FOUNTAIN

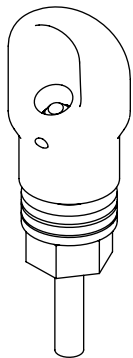

**MODEL 5703M  
BUBBLER HEAD**

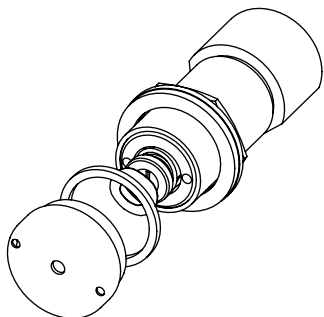

**MODEL 5874PB  
PUSHBUTTON**

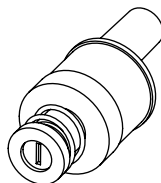

**MODEL VRK5874  
VALVE REPAIR KIT**

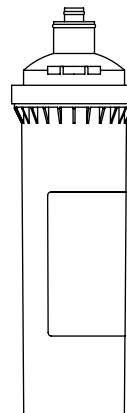

**MODEL 6428  
FILTER CARTRIDGE  
(FOR 36XXF SERIES  
MODELS)**



**MODEL PBA7  
BUTTON ASSEMBLY**

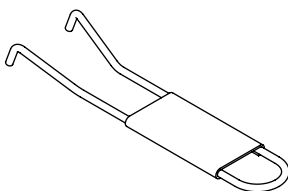

**0006983506  
SPANNER WRENCH**



**0510001030  
HEX BIT,  
PINNED, 5/32"**



**0510001029  
HEX BIT,  
PINNED, 1/8"**

## OPTIONAL ACCESSORIES

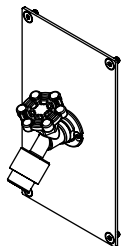

**MODEL 3661 HOSE BIB  
(NOT FREEZE RESISTANT)**

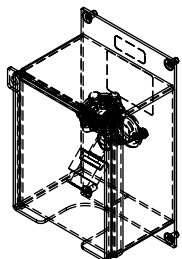

**MODEL 3660 LOCKABLE HOSE BIB  
(NOT FREEZE RESISTANT)**

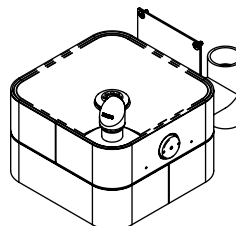

**MODEL 3670 DOG BOWL  
(NOT FREEZE RESISTANT)**

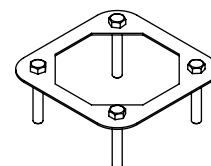

**MODEL MTG.3600  
INSTALLATION AID**

## 3603 & 3603F MODULAR OUTDOOR FOUNTAIN SYSTEM PARTS BREAKDOWN

WHEN ORDERING PARTS, PLEASE  
SPECIFY PART NUMBER

		1455 KLEPPE LANE SPARKS, NEVADA 89431 (775) 359-4712 FAX (775) 359-7424 E-MAIL: HAWS@HAWSO.COM WEBSITE: WWW.HAWSO.COM	
ECN: 5226	REV. ECN: 5794	BY: CC	MODEL(S)
DRAWN: CC	DATE: 09/14/17	CHKD: FV	3603 & 3603F
APPROVED: JU	DATE: 03/21/22	SCALE: 1:2	DRAWING TYPE: PARTS BREAKDOWN
			PART NUMBER: 0510000753
			REVISION: 3
			SIZE: A SHEET 1 OF 2

### AVAILABLE SUB COMPONENT MODELS

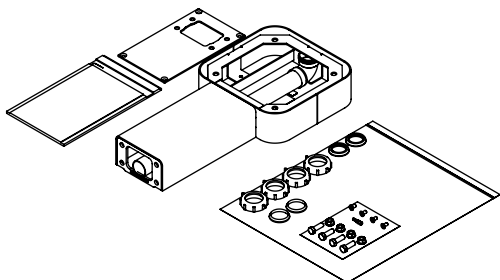

MODEL 3671 PEDESTAL ARM ASSEMBLY

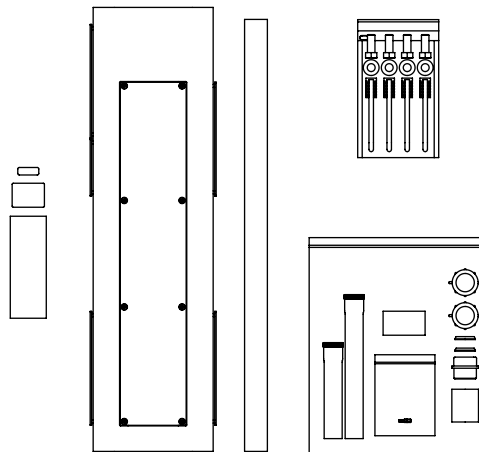

MODEL 3674 PEDESTAL ASSEMBLY

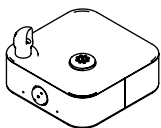

MODEL 3680 FOUNTAIN ASSEMBLY

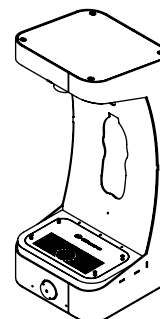

MODEL 3690 BOTTLE FILLER ASSEMBLY

**3603 & 3603F  
MODULAR OUTDOOR  
FOUNTAIN SYSTEM**

## PARTS BREAKDOWN

WHEN ORDERING PARTS, PLEASE  
SPECIFY PART NUMBER

			1455 KLEPPE LANE SPARKS, NEVADA 89431 (775) 359-4712 FAX (775) 359-7424 E-MAIL: HAWS@HAWSO.COM WEBSITE: WWW.HAWSO.COM		
			PART NUMBER 051000753	REVISION 3	
ECN: 5226	REV. ECN: 5794	BY: CC	MODEL(S) 3603 & 3603F		
DRAWN: CC	DATE: 09/14/17	CHKD: FV			
APPROVED: JU	DATE: 03/21/22		SCALE: 1:16	DRAWING TYPE: PARTS BREAKDOWN	SIZE: A SHEET 2 OF 2