



Haws[®]
Since 1906

models **9326 & 9327**
PHD - Parabolic Heat Design Tankless Heater

FEATURES & BENEFITS

MODEL 9326

Unit enclosed in a powder-coated, cold rolled steel NEMA 4 rated cabinet.

MODEL 9327

Unit enclosed in a 304 or 316 stainless steel NEMA 4X rated cabinet.

CONSTRUCTION

Manufactured from NSF-61 listed materials.

SAFETY and RELIABILITY

Thermo-Optical sensor for protection against entrained air or improper commissioning.

CONTROL and CONSUMPTION

Active energy management to ensure optimal application of energy based on real-time systems demands. Multistage element turn-on. Visual interface for field programming. BMS capable.

MODULAR HEATING CHAMBER ASSEMBLY

Up to 6 heating cartridges and up to 12 direct heating elements with molded-in termination rods. Flow, fault codes, and system stations displayed on LCD.

COMPACT POWER

Uses up to 21kW per heating chamber.

PREDICTIVE CONTROL ALGORITHM

Uses a high-capacity flow meter with inlet and outlet temperature sensors to maintain set temperature points.

DIAGNOSTICS

On-board diagnostics with digital LCD display.

MAINTENANCE

Fully serviceable, easy maintenance access.

OPTIONAL FEATURES

- Free-Standing Legs
- Class 1, Division 2*
- GFCI (Ground Fault Circuit Interrupter)*
- Freeze Protected for harsh climates, down to -30° F (-34.4° C)*
- Fused Disconnect Switch*
- Non-Fused Disconnect Switch*
- Dry Contacts
- Remote Display

* The above five options come with a larger enclosure.
See Page 3 for details.



SPECIFICATIONS

54 kW 208v,	Size: 24"H x 30"W x 13.5"D
54-126 kW 480V,	(60.96 cm x 76.2 cm x 34.3 cm)
61-150 kW 600V	Weight: 116 lbs. (52.62 kg)
Rated Pressure:	150psi
Certifications:	208V & 480V heaters are UL listed to ANSI/UL 499 standard 600V heaters are UL listed to CSA22.2 No. 88 standard
Unique Features:	Optic heat sensing safety parabolic heat design
Standard Temp Setting:	85° F (29.4° C)
Temp Accuracy:	+/- 1° at steady state flow
Max Flow Rate:	40 GPM (151.4 LPM)



SAFETY APPLICATIONS

EYE/FACE WASH & DRENCH SHOWERS

Please specify power requirements when selecting a model.

	VOLTAGE (Delta)	POWER (KW)	AMPS	RECOMMENDED WIRE SIZE	TURN-ON (GPM)	PHASE	NPT FITTING	TEMPERATURE RISE IN GPM (°F)								
								3.0	4.0	5.0	6.0	20.0	23.0	26.0	30.0	40.0
Model 9326/9327	208v 3Ø	54	150A/phase	2/0 AWG	1.5	Three	1.25"	123°	92°	74°	61°	18°	16°	14°	12°	9°
Model 9326/9327	480v 3Ø	54	65A/phase	4 AWG	1.5	Three	1.25"	123°	92°	61°	49°	18°	16°	14°	12°	9°
Model 9326/9327	480v 3Ø	72	87A/phase	3 AWG	2.5	Three	1.25"	•	123°	82°	66°	25°	21°	19°	16°	12°
Model 9326/9327	480v 3Ø	108	130A/phase	1 AWG	2.5	Three	1.25"	•	•	123°	98°	37°	32°	28°	25°	18°
Model 9326/9327 (Standard)	480v 3Ø	126	151A/phase	2/0 AWG	2.5	Three	1.25"	•	•	•	115°	43°	37°	33°	29°	22°
Model 9326/9327	600v 3Ø	61	59A/phase	6 AWG	2.5	Three	1.25"	139°	104°	83°	69°	21°	18°	16°	14°	10°
Model 9326/9327	600v 3Ø	102	98A/phase	1 AWG	2.5	Three	1.25"	•	•	139°	116°	35°	30°	27°	23°	17°
Model 9326/9327	600v 3Ø	130	125A/phase	1 AWG	2.5	Three	1.25"	•	•	•	118°	44°	39°	34°	26°	22°
Model 9326/9327	600v 3Ø	150	144A/phase	2/0 AWG	2.5	Three	1.25"	•	•	•	•	51°	45°	39°	34°	26°

• Temperature electronically limited to factory preset not to exceed temperature.

INSTALLATION DRAWING

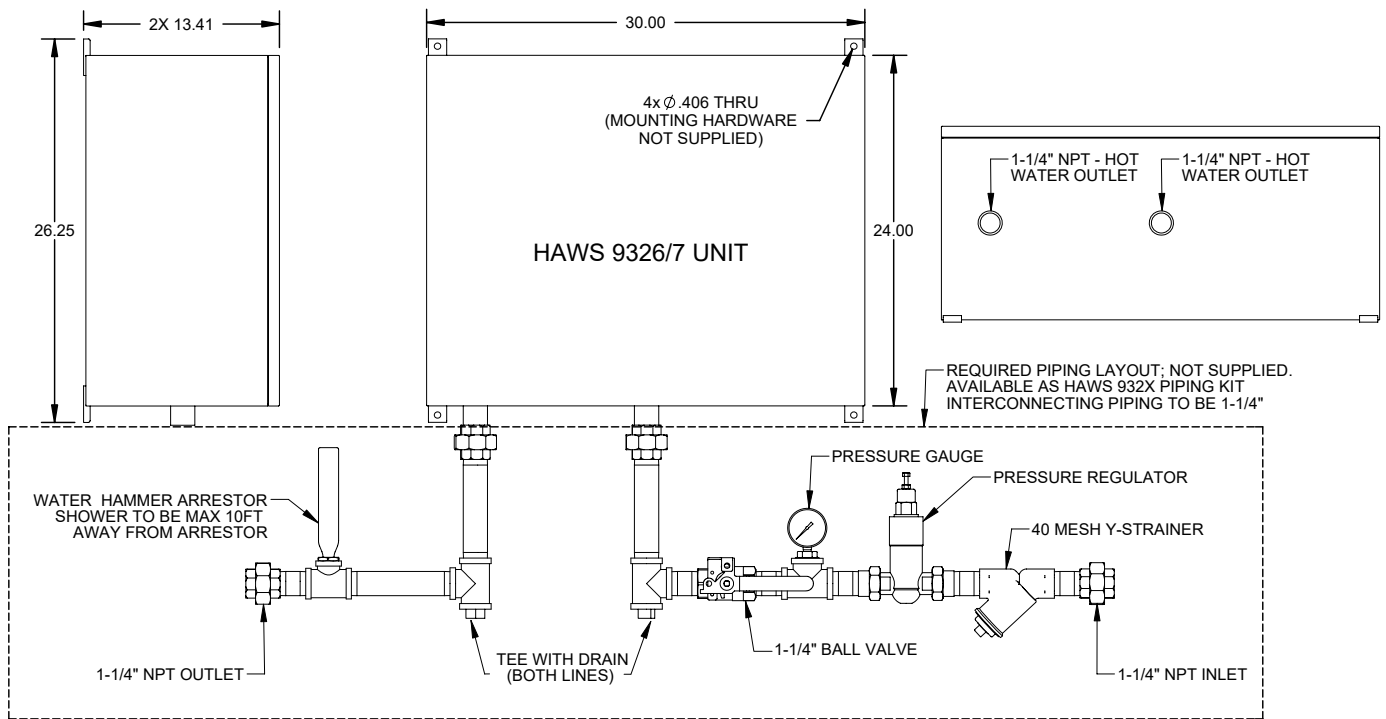

PRESSURE DROP

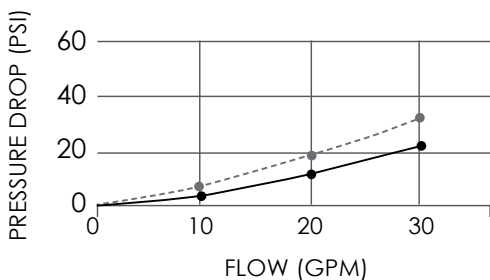

— MODELS 9326 & 9327 - - - - - COMPETITOR

ELECTRICAL CONFIGURATION & REQUIREMENTS

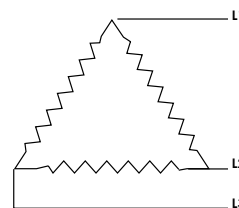

**Three Phase Units
Delta Configuration**

Requires: 3 Lives and
1 Ground (earth)

OPTIONS

FP - Freeze Protected

- Internal thermostatically-controlled enclosure heater
- Enclosure heater element capacity: 1200W
- Heater protects internal components to -30° F (-34.4° C)
- Insulation: water-resistant Neoprene foam gasket
- IP Rating: 66

GFCI - Ground Fault Circuit Interrupter

- True RMS GFCI
- Digital display
- Enclosed manual reset

Non-Fused Electrical Disconnect Switch

- UL98 indoor disconnect
- Rated at 600v with 200 amp capacity
- Pistol grip lock out tag out handle NEMA 4/12/3R rated

Fused Electrical Disconnect Switch

- UL98 indoor disconnect
- Rated at 600v with 100 or 200 amp capacity
- Pistol grip lock out tag out handle NEMA 4/12/3R rated
- Up to 200 kA Short-Circuit Current Rating (SCCR)
- J-Type fuse with finger-safe covers

EP - Explosion Proof

- Large-volume pressurization purge controller (volume up to 90 cubic feet) 3003 WPS, NEC Type Z Class 1 Div 2, Groups C and D classified by FM Approvals, NFPA 496 - 1993

Dry Contacts

- 3P 60A Normally open contact, activates when unit is generating heat

Remote Display

- Relocates operator interface external to cabinet in Nema 4X enclosure with 4 ft lead

NEMA 4/4X ENCLOSURE

- NEMA 4 or 4X cabinet required when choosing any of the below options, FP, GFCI, EDS, and/or EP
- NEMA 4 powder-coated, waterproof, and pressurization enclosure
- NEMA 4X stainless steel, waterproof, corrosion-resistant, insulated, and pressurization enclosure for harsh outdoor environments. Available in 304 or 316 Stainless Steel.
- Enclosure Type: UL508A listed type 4 wall-mounted enclosure
- Enclosure Material: 14 GA Steel
- External Height A: 36" (91.44 cm)
- External Width B: 30" (76.2 cm)
- External Depth C: 17" (43.18 cm)

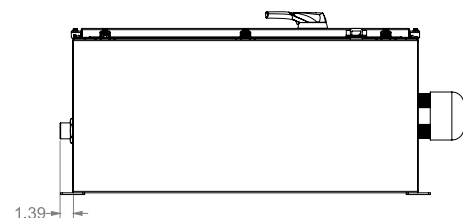
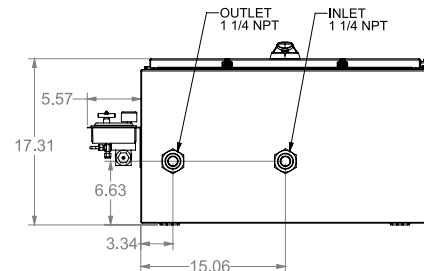
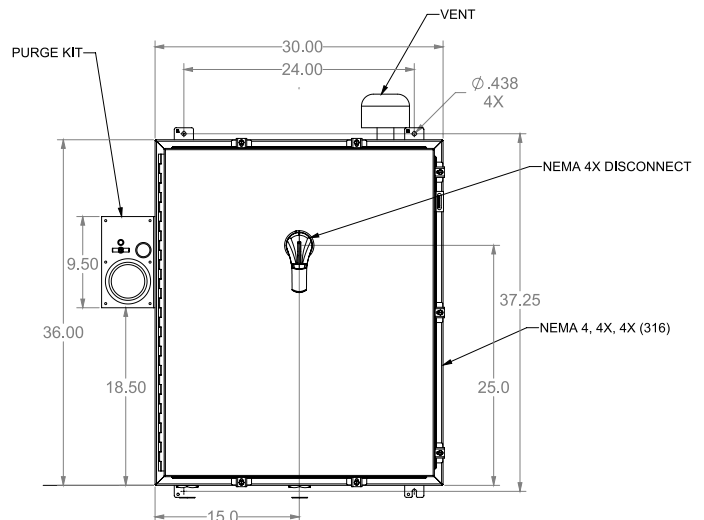

MODEL CONFIGURATION OPTIONS

Complete your custom configuration by selecting the options and their corresponding number.
Place the number in the allocated order to complete your configuration.

models 9326 or 9327

X X X X X X X X X

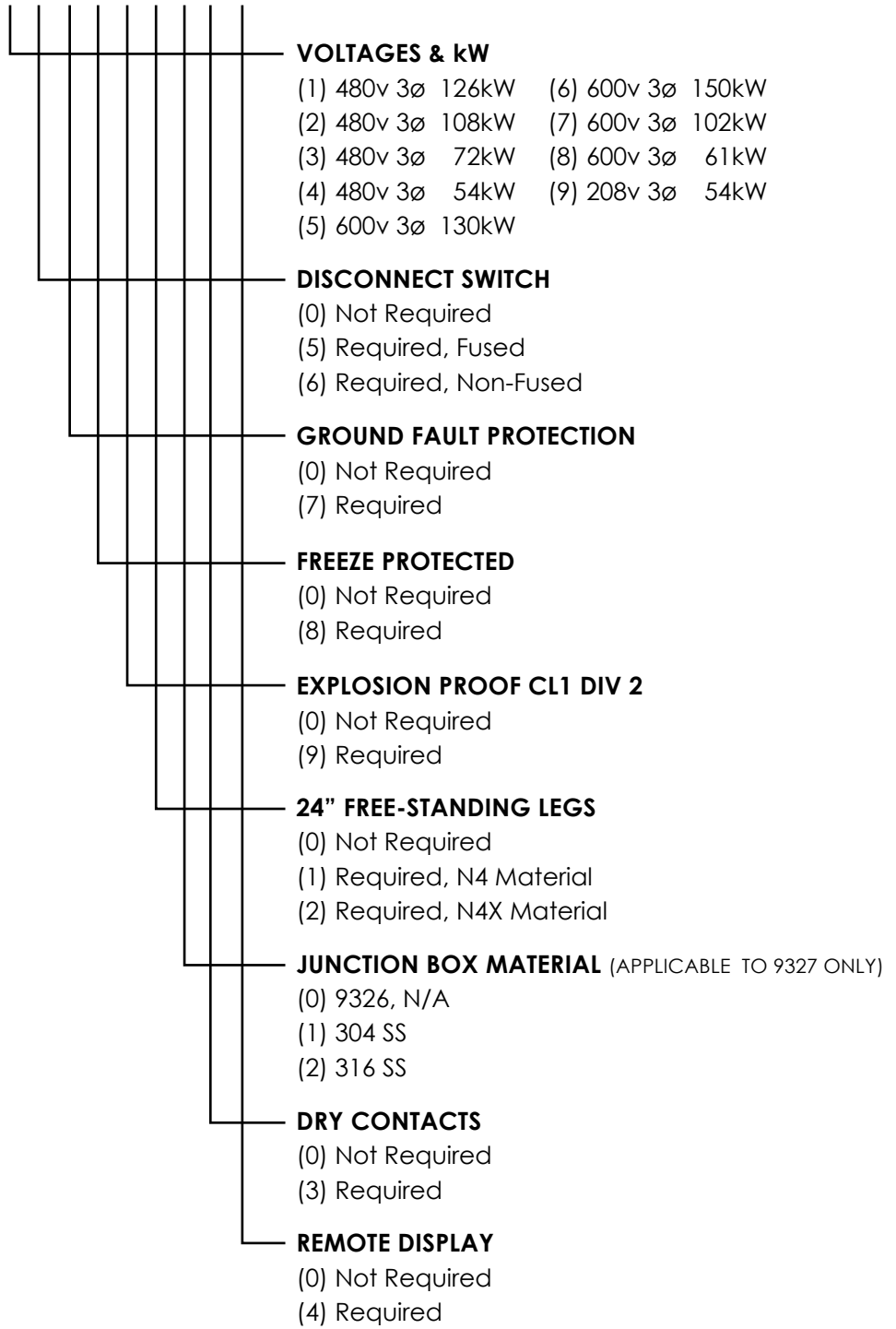

Your configuration model _____.

Questions? Call Haws Customer Service at 775.359.4712