



INSTALLATION, OPERATION & MAINTENANCE INSTRUCTIONS

1455 Kleppe Lane ♦ Sparks, NV 89431-6467 ♦ (775) 359-4712 ♦ Fax (775) 359-7424
E-mail: haws@hawsco.com ♦ website: www.hawsco.com

No. 2080114(14)

Model 8122 Drench Shower

NOTE TO INSTALLER: Please leave this information with the Maintenance Department.

LIMITED WARRANTY

HAWS® warrants that all of its products are guaranteed against defective material or poor workmanship for a period of **one year from date of shipment**. HAWS liability under this warranty shall be discharged by furnishing without charge F.O.B. HAWS Factory any goods, or part thereof, which shall appear to the Company upon inspection to be of defective material or not of first class workmanship, provided that claim is made in writing to company within a reasonable period after receipt of the product. Where claims for defects are made, the defective part or parts shall be delivered to the Company, prepaid, for inspection. HAWS will not be liable for the cost of repairs, alterations or replacements, or for any expense connected therewith made by the owner or his agents, except upon written authority from HAWS, Sparks, Nevada. HAWS will not be liable for any damages caused by defective materials or poor workmanship, except for replacements, as provided above. Buyer agrees that Haws has made no other warranties either expressed or implied in addition to those above stated, except that of title with respect to any of the products or equipment sold hereunder and that HAWS shall not be liable for general, special, or consequential damages claimed to arise under the contract of sale.

The emergency equipment manufactured by HAWS is warranted to function if installation and maintenance instructions provided are adhered to. The units also must be used for the purpose which they were intended. This product is intended to supplement first-aid treatment. Due to widely varying conditions HAWS cannot guarantee that the use of this emergency equipment will prevent serious injury or the aggravation of existing or prior injuries.

NO OTHER WARRANTIES EXPRESSED OR IMPLIED ARE AUTHORIZED, PROVIDED OR GIVEN BY HAWS.

SHOULD YOU EXPERIENCE DIFFICULTY WITH THE INSTALLATION OF THIS MODEL, PLEASE CALL:

1-800-766-5612

FOR PARTS CALL:

1-800-758-9378

**(U.S.A. AND CANADA ONLY) MONDAY-THURSDAY: 6:00 A.M. – 4:00 P.M. PST
FRIDAY: 6:00 A.M – 1:00 P.M. PST**

LOCATION OF UNIT: The Model 8122 Emergency Drench Shower should be installed in close proximity to potential accident areas. It should be clearly identified free from obstructions and easy to access.

SUPPLY LINE: The minimum recommended line size is 1" IPS with 30-90 psi (2-6 ATM) flowing supply line pressure. Where sediment or mineral content is a problem, an inlet filter is recommended.

PLUMBING CONNECTIONS: Inlet supply is female 1" NPT.

Horizontal Supply to Vertical Supply Conversion

Refer to Installation Drawing for clarification. Check parts list to insure all required parts are included. Use pipe joint sealant PST #565 (Loctite) on all connections.

STEP 1: Remove the nipple (1" x 12-1/2") from the ball valve.

STEP 2: Attach nipple (1" x 3-1/2" - supplied) onto valve.

TROUBLESHOOTING	
PROBLEM	REPAIR CHECKLIST
1. No flow.	1. Check the main shut-off valve.
2. Insufficient water flow.	2. a. Verify minimum 30 psi (2 ATM) flowing supply line pressure. b. Probable clogging of flow control inside shower head. Unscrew shower head off of elbow and clean rubber flow control.

For more information about Haws products, see our website: www.hawesco.com

PARTS BREAKDOWN

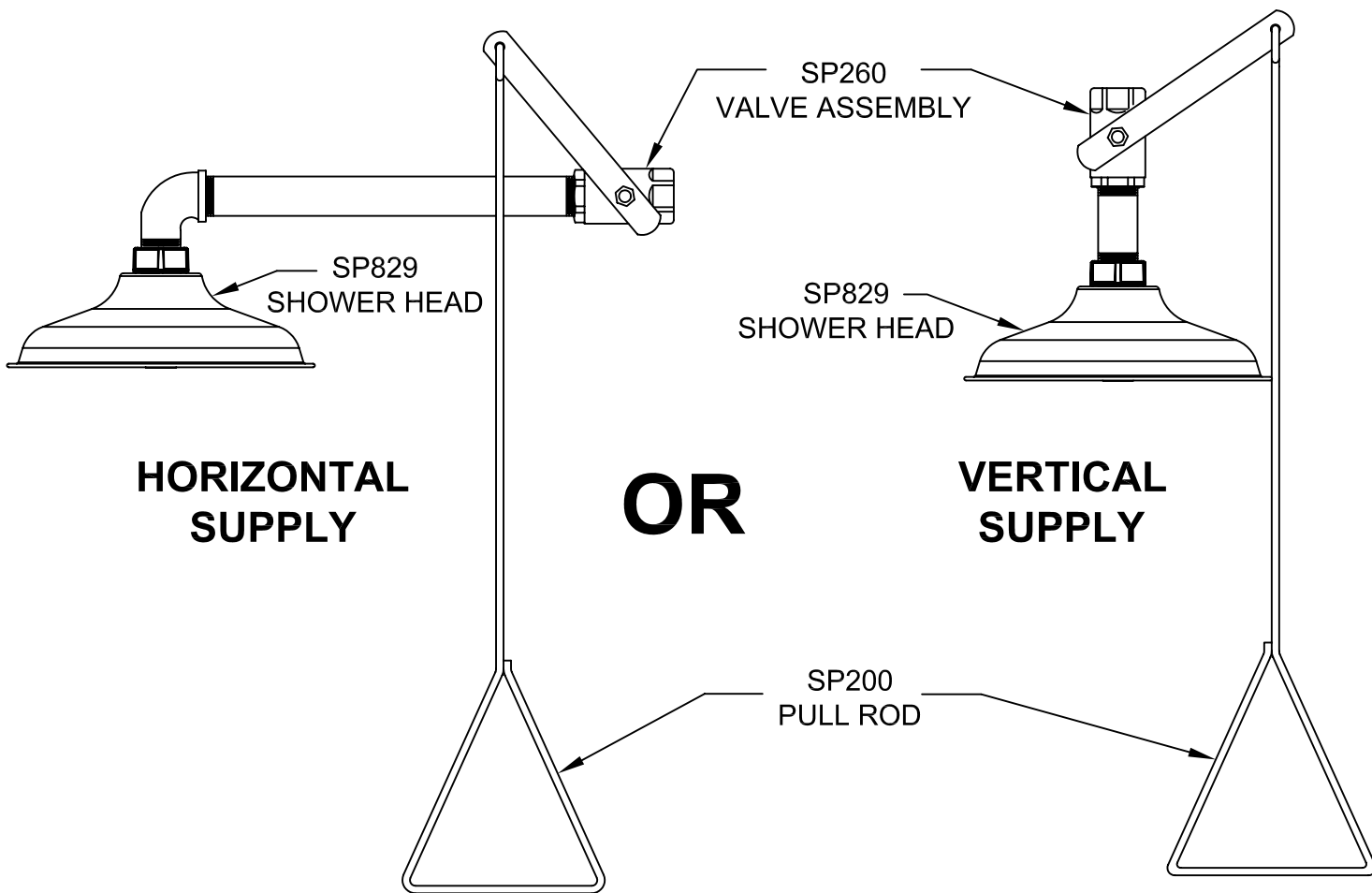

SP170
TEST TAG

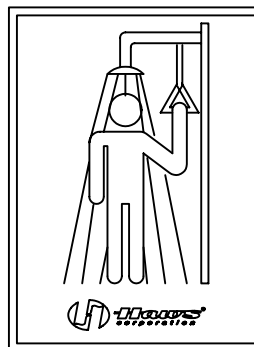

SP177
SHOWER SIGN

REV	DESCRIPTION	ECN	DATE	BY/APVD
14	UPDATED PER ECN	4367	12/2/09	IR
REVISIONS				

WHEN ORDERING PARTS PLEASE SPECIFY YOUR MODEL NUMBER



1455 KLEPPE LANE
SPARKS, NEVADA 89431
(775) 359-4712 FAX (775) 359-7424
E-MAIL: HAWS@HAWS.CO.COM
WEBSITE: WWW.HAWS.CO.COM

DRAWN BY: CLF	DATE: 3/08/93	CHECK BY:	APVD BY:	SCALE: 1/3
TITLE: MODEL 8122			PART NUMBER: 0002080114	
DRAWING TYPE: PARTS BREAKDOWN			DRAWING NUMBER: 11473C00	REV: 14

HORIZONTAL SUPPLY (STANDARD)

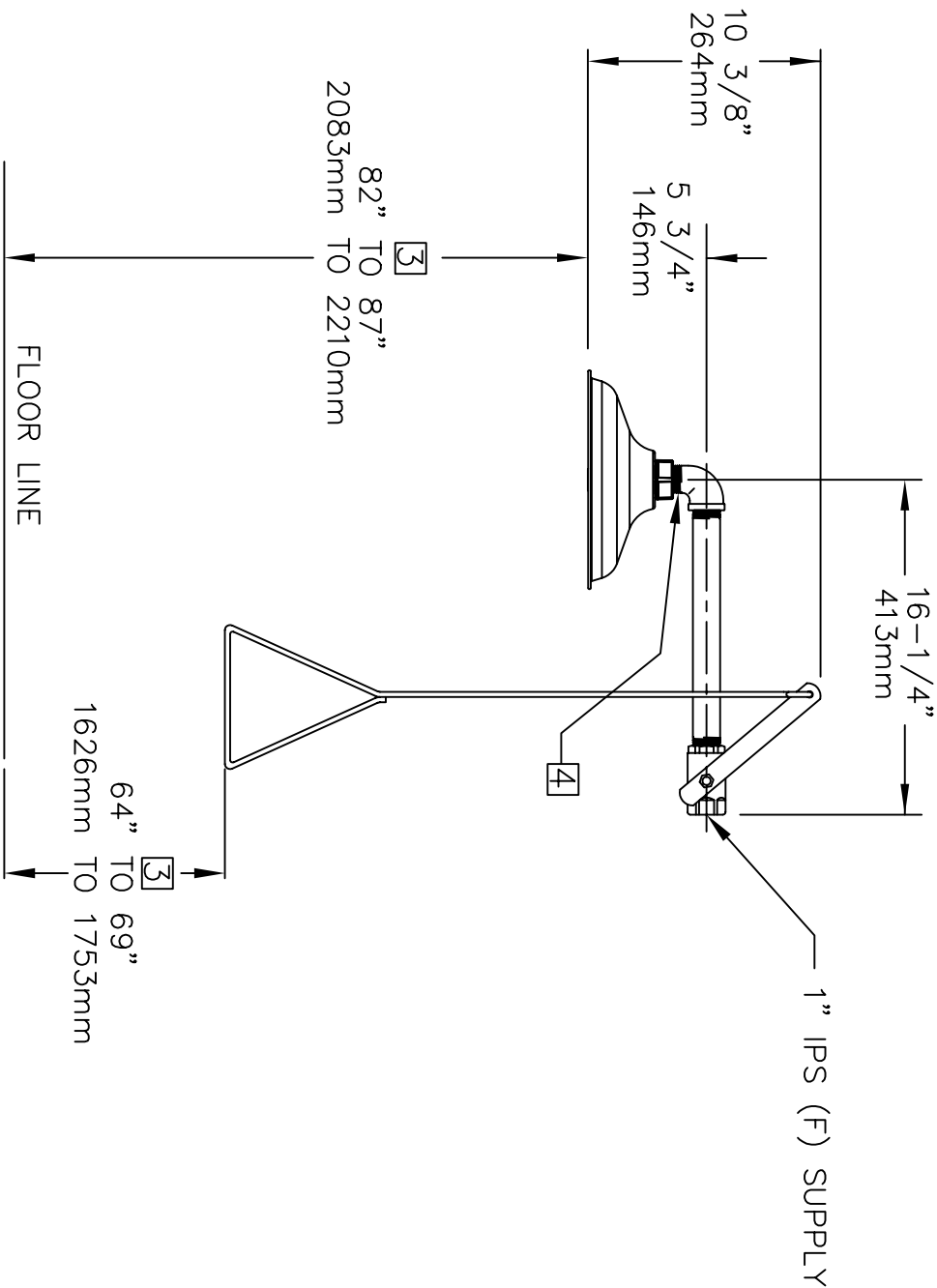

**SEE SHEET 2 OF 2 FOR
CONVERSION TO VERTICAL
SUPPLY CONFIGURATION**

NOTES:

1. DIMENSIONS MAY VARY BY ± 1/2 INCH [13mm].
2. TO COMPLY WITH ANSI Z358, 1-2009 FOR EMERGENCY EYEWASH OR EYEFACE WASH AND SHOWER EQUIPMENT:
 - UNIT SHALL BE INSTALLED IN ACCORDANCE WITH MANUFACTURER'S INSTRUCTIONS AND ACCEPTABLE PLUMBING PRACTICES.
 - SHOWER SHALL BE POSITIONED SO THAT SHOWER HEAD IS NOT LESS THAN 208.3 CM (82 IN.) NOR MORE THAN 243.8 CM (96 IN.) FROM SURFACE ON WHICH USER STANDS.
 - SHOWER SPRAY PATTERN SHALL HAVE A MINIMUM DIAMETER OF 50.8 CM (20 IN.) AT 152.4 CM (60 IN.) ABOVE SURFACE ON WHICH USER STANDS, AND CENTER OF SPRAY PATTERN SHALL BE LOCATED AT LEAST 40.6 CM (16 IN.) FROM ANY OBSTRUCTION.
3. FOLLOWING THESE DIMENSIONS WILL AUTOMATICALLY PROVIDE ADHERENCE TO ANSI REQUIREMENTS STATED ABOVE.
4. DO NOT USE REGULAR PIPE SEALANT. IF NECESSARY USE DOW CORNING 832 SEALANT PLACING 5 SMALL BEADS ON THE MALE THREADS, JUST ABOVE THE FIRST THREAD.

		<p>1455 KLEPPE LANE SPARKS, NEVADA 89431 (775) 359-4712 FAX (775) 359-7424 E-MAIL: HAWS@HAWS.CO.COM WEBSITE: WWW.HAWS.CO.COM</p>	
<p>EQN NO. 1-2009-001 DATE: 5/19/09 C.I.L. APPROVER:</p>	<p>DESIGNED BY: HR CHECKED BY: HR DATE: 5/19/09</p>	<p>MODEL(S): 8122 DRENCH SHOWER INFO FAX DOC #: 281224</p>	<p>ORDER NO. 0020801 REV. 14.D 09416A00 14</p>

**FOR VERTICAL
SUPPLY
(RECONFIGURE AS SHOWN)**

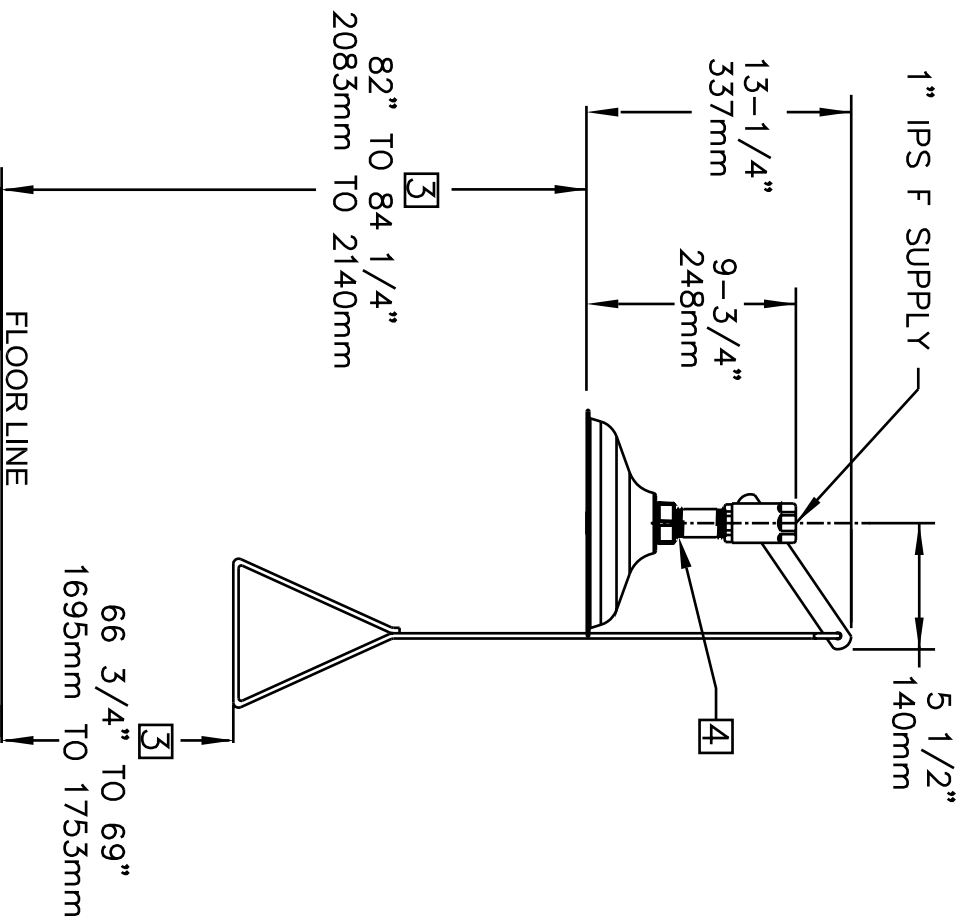

REMOVE ELBOW
AND PIPE FROM
ASSEMBLY

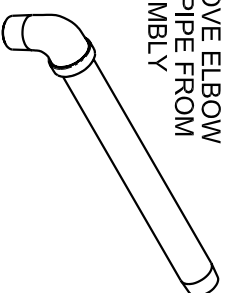

REMOVE HANDLE,
FLIP COMPLETELY
TO OTHER SIDE.
REATTACH.

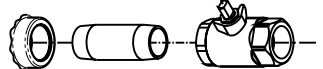
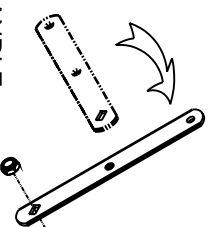

ASSEMBLE
SHORTER 3-1/2"
NIPPLE (SUPPLIED)
SHOWER
HEAD

AGE ON WHICH
USER STANDS, AND CENTER OF SPRAY PATTERN SHALL BE LOCATED AT LEAST 40.6 CM (16 IN.) FROM ANY OBSTRUCTION.

3 FOLLOWING THESE DIMENSIONS WILL AUTOMATICALLY PROVIDE ADHERENCE TO ANSI REQUIREMENTS STATED ABOVE.

4 DO NOT USE REGULAR PIPE SEALANT. IF NECESSARY USE DOW CORNING 832 SEALANT PLACING 5 SMALL BEADS ON THE MALE THREADS, JUST ABOVE THE FIRST THREAD.